

ADVANCING business opportunities

imageRUNNER ADVANCE
Office Colour and Black and White Range



come

and

see



The next generation imageRUNNER ADVANCE

The way we work today would have been unthinkable 20 years ago. Flexible start times, working from home, mobile workers who share desks, and employees who cross international boundaries yet interact as if they were in the same room. Today businesses must be able to respond quickly; not just to the fast-evolving demands of customers but also to the fast-developing opportunities that technology plays in creating competitive advantage.

“”

By 2020 the world will generate **50** times the amount of information and **75** times the number of “information containers” while IT staff to manage it will grow less than 1.5 times.

IDC Digital Universe Study, sponsored by EMC, June 2011



Information defines success

It is often said that information is power, but today's forward-thinking organisations appreciate that information per se isn't an asset. Now successful businesses must be able to gather and present information instantly, share it quickly with those that need it, and keep it secure from those that don't. As information today takes multiple forms and co-exists in various locations – from employees' desks and office cabinets to cloud servers and mobile devices – getting things right poses a sizeable challenge.

More than ever before, documents are the conduits of this information. They convey emotion, communicate ideas, persuade, teach and inform – both electronically and in hard copy. That's why it's crucial to employ a document and print platform that allows you to manage documents and information in the most efficient and effective ways possible.

The next-generation imageRUNNER ADVANCE

The imageRUNNER ADVANCE is an intelligent document communication platform designed to support the goals of your business and to be adaptive to the fast-changing environment we live in. It is built to complement every stage of the document lifecycle: from creation to management, output to archival, whilst supporting your security and environmental goals.

For every work environment

From small workgroups and offices to large departments or print rooms, the versatile and extensive imageRUNNER ADVANCE range is designed to address the document-handling needs of every working environment. Whether high quality colour or efficient black and white output, low or high volume, there is an imageRUNNER ADVANCE that can be tailored to meet your output and capture requirement.



Mobile workers represented 54% of the total workforce population in 2014 and are forecast to rise to 75% by 2018.

IDC, Western European Mobile Workforce Forecast Update, # LM58W

Next-level productivity

Doing business with fewer resources, or in less time, is always a hot topic at management meetings. When designing the imageRUNNER ADVANCE, the same was true at Canon. How can we help your business be more effective by being more productive? The outcome is a range that constantly impresses, getting the job done quicker and more easily than ever before.

Ease of use

A large user interface is the focal point of every device. The high definition colour touch screen makes carrying out tasks effortless, while the tilt function gives users the freedom to adjust the screen angle as best suits. Menus are logically structured and intuitive making task completion simple for novices, with a built-in tutorial and help information selectable, should further guidance be needed.

The entire imageRUNNER ADVANCE range is built using a common platform and operating principles, so once familiar with one device, you can use any other, making multi-device deployments easy to implement.





51% of smartphone users do not know that they can print from their smartphones, 22% don't know how to print and 5% find it too challenging

IDC European Mobility Study, 2014

Advanced document capture

Each device can act as a hub for document capture and digitisation of workflows through its powerful scanning capabilities. With standard support for both optical character recognition and Office Open XML formats such as PowerPoint or Word, you can capture and reuse paper information within any electronic workflow. Image readers simultaneously scan both sides of paper for super-quick results, and you can easily send scanned documents to a multitude of destinations including e-mail, fax, folder, FTP and cloud based systems.

For complete process or workflow optimisation, all iR-ADV devices integrate tightly with a range of powerful Canon and third party output and information management software thanks to the embedded MEAP and MEAP Web application platforms.



Every imageRUNNER ADVANCE features a large intuitive high definition colour touch screen.

Support for mobile working

The imageRUNNER ADVANCE provides scalable support for mobile and flexible working practices to increase workforce efficiency. Powerful MEAP applications allow users to print from any Google Cloud Print enabled web and mobile app, or scan to and print from iPad, iPhone and Android mobile devices. Alternatively, within Canon's uniFLOW solution, centralised mobile printing capabilities allow users to print many file formats, from any platform and to any device - all without compromising security or cost control.

Create personal workflows

Every imageRUNNER ADVANCE device is designed to be shared, but also provides opportunities for a unique, personal experience. Once logged in, users are presented with a workspace that can be fine-tuned to suit. Common tasks, such as scanning into business applications or sending documents to group addresses, can be transformed into personal one-touch buttons for quick and easy execution. In fact, even the touch screen's wallpaper, as well as button layout and size, can be defined so that every user's interaction with the device is unique.

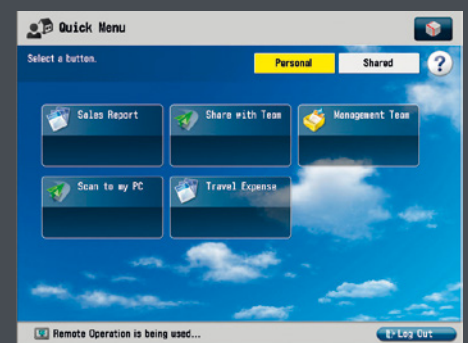
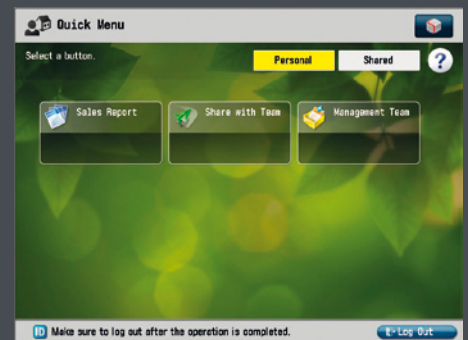

The look and feel of the screen can be personalised for each user, and personal workflows can be set to increase convenience and productivity.



Canon, Inc.

2013 Document Imaging Solutions
Line of the Year

Communication that differentiates

The ability to communicate effectively allows you to motivate and inspire others, convey direction, and connect with customers. The imageRUNNER ADVANCE platform facilitates this, delivering glorious colours and pin-sharp image quality with every print. A variety of tools help you to easily create the most impressive and professional-looking business documents and marketing collateral.



Quality printing

Whether you're printing a key sales proposal, or merely an internal email, expect outstanding output every time. The imageRUNNER ADVANCE uses a unique oil-free toner, impressive 1,200 dpi resolution, and advanced real time calibration to provide the crispest black and white and most vibrant colour prints imaginable.

Outstanding colour productivity

A choice of high-performance Fiery-based controllers from the industry leader EFI allows customers with frequent, large and graphically intensive jobs, to benefit from higher productivity and optimised functionality. Supporting simultaneous PostScript as well as end-to-end PDF workflows, these controllers guarantee colour accuracy and consistency – crucial for design professionals and marketing departments. In addition, personalised marketing collateral such as direct mail or campaign materials can be created quickly and efficiently with advanced Fiery Variable Data Printing capabilities.

“”

50% of our customers say that producing good-looking, high-quality documents is a key factor in their organisation's success¹

¹Canon commissioned independent specialist market research company RS consulting to undertake the research (working title: 'Canon Office Insights') 1662 end-users and decision-makers across Europe were questioned online throughout September 2012

iW Desktop enables easy creation of professional finished documents through combining and editing files and pages from various applications.



Professional document publishing

Document creation and publishing takes on a new meaning with Canon's iW Desktop document publishing software. It allows you to effortlessly take files created in different applications (such as Word or Excel), combine and edit them with drag-and-drop simplicity, before applying finishing. In this way, impressive, professional-looking customised sales proposals, reports, training materials, and more can be produced in minutes rather than hours.

The imageRUNNER ADVANCE Quick Printing Tool also allows you to print, fax or convert documents to PDF files without opening the native application and printer driver – another time-saving benefit. Plus, PDFs can be compressed and annotated by different users, allowing collaborative workflows and proofing processes to be simply established.

Personalised documents

With iW Desktop's variable data printing it's easy to create personalised versions of your document in an instant - simply drag and drop variable text fields into your document and iW Desktop will create personalised versions for you based on a simple Excel or CSV file.

Microsoft Office Integration

You have spent time creating your documents in Microsoft Office - now make them stand out with quick and easy finishing. With iW Desktop's Office Toolbar you can apply your own finishing templates directly from within Microsoft Word, PowerPoint or Excel. This means finished documents can be created in seconds, without having to navigate through printer driver settings.



iR-ADV Quick Printing Tool



Canon, Inc.

iW Desktop Quick Printing Tool
Outstanding Achievement
in Innovation

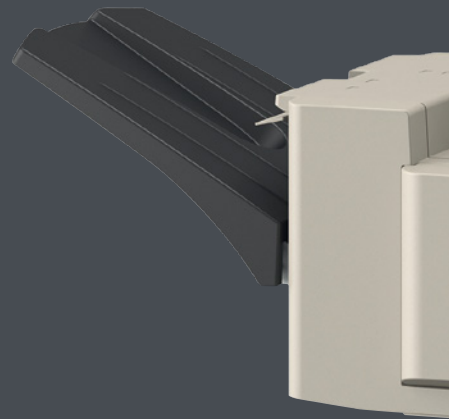

High-level integration

As a communication hub and a focal point for information exchange, today's multifunctional devices are vastly different to those of yesterday. The imageRUNNER ADVANCE enhances how you work by being able to seamlessly integrate with existing systems and processes, while being readily adaptable to the demands of the future.



Canon, Inc.

2013 Document Imaging Solutions
Line of the Year



Seamless integration

The imageRUNNER ADVANCE supports industry standards such as PCL and PostScript and complies with network standards and security policies, so it easily becomes a fully operational part of your network. It also integrates with ERP systems such as SAP, and supports printing from Linux/Unix environments and legacy systems.

Collaboration with external systems such as Adobe Rights Management and SharePoint is also possible, including a number of cloud based services.

Supporting your business

Through the embedded MEAP platform, the device integrates tightly with a range of powerful capture and document output management solutions such as uniFLOW, eCopy, Therefore, IRIS and more.

This allows you to easily adapt and customise your imageRUNNER ADVANCE environment to match the specific requirements of your business or industry sector.

Advanced device management

Canon's device management tools enable you to easily configure, manage and upgrade your imageRUNNER ADVANCE - whether individually or as part of a larger fleet. Using iWMC you can check device status and consumables, capture meter readings, as well as manage address books and print drivers. Firmware, device configurations and applications can be instantly updated across the network and even international boundaries using the same effortless process. All these capabilities ensure that your devices can be integrated smoothly and efficiently to support your daily business operation.





Easily customise the imageRUNNER ADVANCE login screen to show your company logo or other details and use your building access cards to login to the device.

Advanced cost control

In a fast-changing world, maintaining control of critical processes and keeping operating costs low is a pressing issue for businesses. When it comes to document output and management, the imageRUNNER ADVANCE provides all the tools you need to stay in control – whether you are a small business with just a few employees or a multinational operating across borders.

Control access

The award-winning Universal Login Manger is a unique server-less application that enables controlled device access, based on local device authentication or using Active Directory. Authentication at the device can be as simple or as sophisticated as you require, for example from touching your avatar on the screen to using PIN codes and passwords or user proximity cards.

Track and control activity

It's easy to monitor the activity of users within your organisation through reports, and you can use the information to identify potential areas where savings can be achieved. For example, by encouraging more double-sided printing or printing in black and white. Identified action areas can be implemented using the built-in Access Management System, which allows you to apply restrictions to certain device functions such as scan and send, or copy and print in colour on a per user basis. This helps to control costs and also adds another level of security around your device.

Ultimate control with uniFLOW

For businesses that demand the highest levels of control, Canon's uniFLOW solution can be configured together with the imageRUNNER ADVANCE. This provides sophisticated cost tracking and accounting capabilities, including detailed reporting and cost centre selection for cost allocation. Intelligent routing enables the administrator to define how documents are printed when certain conditions are matched, and automatically redirect print jobs to the most efficient device on the network, reducing overall print costs.



Canon, Inc.
 Universal Login Manager
 Outstanding Achievement
 in Innovation

Multifunctional collaboration

The imageRUNNER ADVANCE is a smart multifunctional that handles the work of many devices in one, making document communication and collaboration cost effective and easy. Furthermore, functionalities of one device, such as fax, Address Books or Advanced Space, can be shared with other devices on your network in a client-server relationship, for added efficiency.

Uptime and reliability

A number of tools are incorporated to enable service providers to deliver the highest levels of proactive maintenance. Thanks to the remote monitoring and diagnostics capabilities of eMaintenance, toner stock onsite can be managed and replenished easily, and accurate meter readings can be collected in an automated fashion. Remote diagnostics, event handling and parts lifetime management ensure pre-emptive maintenance and rapid fixes.

All these allow you to enjoy uninterrupted device uptime, reduce the burden on your IT or facilities department, and help to deliver the maximum return on your investment.



Managed print services can reduce your printing costs by **10% to 30%**

Gartner, How to Select a Managed Print Services and Managed Content Services Provider, May 16, 2014

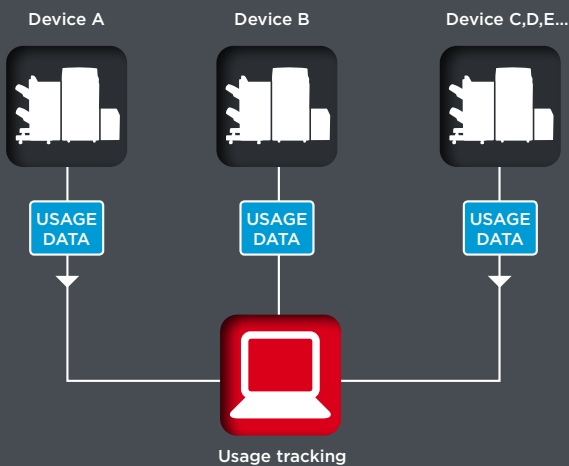

Collect basic usage statistics from your imageRUNNER ADVANCE to generate reports per user or device.

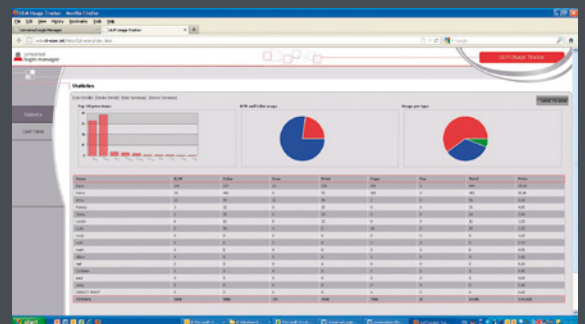

Universal Login Manager reporting



The **forefront** of security

It's an age-old maxim that people are an organisation's greatest asset. But in the digital world, these beliefs are being challenged: it is information that makes businesses successful, and the ability to act upon the opportunities it presents. With MFDs operating as hubs of this information and security worries at an all-time high, protecting this asset is critically important. Thankfully, imageRUNNER ADVANCE offers an extensive portfolio of security features that keep confidential information as it was intended.

“““

Did you know that **33%** of office employees have seen confidential information on printers and copiers?

Canon's unique Data Loss Prevention solution allows you to monitor what users are printing, copying and scanning at the multifunctional device. It can also prevent unauthorised users from printing or scanning documents that contain sensitive information, reassuring you that your important information will stay secure.

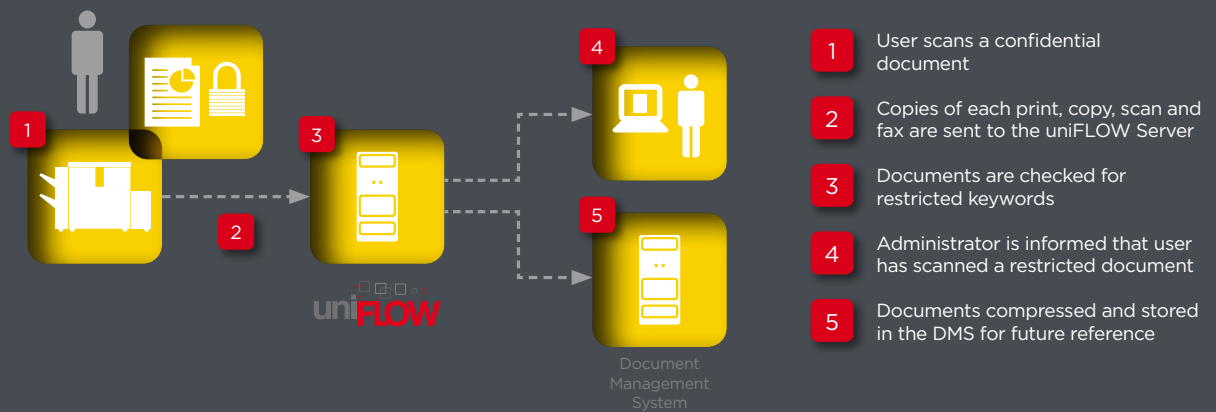

Network security

The imageRUNNER ADVANCE provides standard IPsec functionality which ensures information privacy and security for the internet protocol (IP) over the network. The device can also be set-up to only allow specific IP or MAC addresses to contact it, for example only the print server's IP or MAC address, with all other incoming network traffic blocked. In addition, IP address filters for outbound communication can be set-up, preventing data falling into unauthorised hands, while Secure Sockets Layer (SSL) protects data transferred over the network through strong encryption.



Device security

You can increase the security of your imageRUNNER ADVANCE by controlling who has access to it via the Universal Login Manager application. Numerous other features enable additional protection of the information stored on your device. You can set to erase all data from the device memory after job completion through the standard data erase functionality. Data can also be protected by encrypting it using the optional data encryption kit, which has achieved Common Criteria certification. Plus, the hard disk can be removed for storing in a secure location outside business hours, for protection against security risks.

Confidentiality

Native secure print functionality means that sensitive prints can only be retrieved when the user has entered the correct PIN code which was set at the driver by the document owner – preventing sensitive documents from piling up in the output tray. Device mailboxes can be protected with a PIN code to restrict unauthorised access. Canon's uniFLOW provides a "My print anywhere" capability, allowing users to authenticate and retrieve jobs at any device on the network for added security and flexibility.

Document security

Scan lock option restricts unauthorised copying, sending, and faxing of documents, and also helps track where documents originated. Secure watermarks also discourage copying of sensitive documents. Document authenticity can be guaranteed with user and device signatures, while scanned PDFs can be password protected before being sent from the device.

Data loss prevention

Canon offers the industry's first Data Loss Prevention solution through uniFLOW SAM Express Server. Any print, fax, scan and copy activity passing through your company can be monitored, with rules instantly determining whether access to it should be granted or not.



70% of respondents in recent Quocirca study indicate that they have suffered one or more accidental printing-related data breaches.



A benchmark in **environmental** care

In today's climate it's important to take decisions that make sense now, as well as in the future too. The progressive thinking behind the imageRUNNER ADVANCE embodies this philosophy. Here is a range that unites a sensible financial outlay, efficient running costs, superior levels of control and the new benchmark in environmental responsibility.



Energy efficiency

The entire imageRUNNER ADVANCE range uses Canon's on-demand fixing technology which allows the devices to power up quickly whilst saving energy at the same time. The imageRUNNER ADVANCE protects against unnecessary energy wastage, incorporating automatic timers that can shut down devices when idle, or at the end of the working day or week.

Defining standards

The award-winning imageRUNNER ADVANCE devices offer class-leading Typical Electricity Consumption (TEC) ratings*. Sleep mode cuts consumption to as little as 1W, and the noise levels of devices as well as their finishing accessories have been carefully considered to create a better working environment.

Act responsibly

Print easily using both sides of paper for professional results that also cut paper consumption at the same time. Secure printing means documents can be "held" until users are ready to collect them at the device - preventing wastage caused by forgotten prints discarded in output trays.

Sustainable design

Each device incorporates recycled materials and bioplastics, made from plant-derived resources. Carbon dioxide emissions are reduced through the use of more sustainable materials as well as a design and manufacturing process which focusses on minimising environmental impacts.



* Defined by ENERGY STAR
(<http://www.eu-energystar.org>)



Canon, Inc.







A3 MFP Line of the Year Award
for Energy Efficiency







imageRUNNER ADVANCE

office **colour range**









The imageRUNNER ADVANCE gives you the capability to do more, faster and more effectively than ever before. Share crucial information with colleagues, create incisive reports to gain board approval, or produce professional colour presentations and sales materials to win new customers.



Core Functions	Print/Copy/Scan/Send/Fax*						
Reader/Document feeder	Standard duplex (reversing) 50 sheets						
Scan Speed (A4, 300 dpi)	C250i: Up to 25 ipm (one-side), Up to 9 ipm (double sided) C350i/C351iF: Up to 35 ipm (one-side), Up to 11 ipm (double sided)						
Copy/Print Speed A4	<table border="0"> <tr> <td>C250i</td> <td>C350i/C351iF</td> </tr> <tr> <td> 25ppm</td> <td> 35ppm</td> </tr> <tr> <td>(BW/colour)</td> <td>(BW/colour)</td> </tr> </table>	C250i	C350i/C351iF	 25ppm	 35ppm	(BW/colour)	(BW/colour)
C250i	C350i/C351iF						
 25ppm	 35ppm						
(BW/colour)	(BW/colour)						
Warm-up time	34 sec (normal mode) 10 sec (quick start mode)						
First copy out time	C250i: 8.4 sec BW/10.5 sec colour C350i/C351iF: 5.9 sec BW/7.4 seconds colour						
User Interface	17.8 cm (7 inch) TFT WVGA Colour LCD Touch Panel						
Paper capacity Std	C250i/C350i: 650 sheets, C351iF: 2,300 sheets						
Paper capacity Max	2,300 sheets						
Paper size	Up to A4						
Paper weights	Cassette/s : 60 to 163 gsm. Mutli-purpose tray: 60 to 220 gsm Duplex: 60 to 163 gsm						
Printer language	UFRII , PCL5/6 Standard Genuine Adobe PS3						
Processor	1.66 Ghz						
Memory/Hard Disk Drive	2.0 GB Memory and 160 GB Hard Disk Drive (usable space 80 GB)						
Interface	Ethernet (1000BaseT/100Base-TX/10Base-T), USB 2.0 Hi-Speed						
Power Consumption Sleep Mode	1 Watt or less						
Power Consumption Max	1.5 kW						
Finishing options	Staple Finisher						

imageRUNNER ADVANCE C250i/C350i/ C351iF							
Efficient high quality colour output for busy workgroups and small departments, these compact and smart multifunctionals will enhance your document workflows and safeguard confidential information.							
Print/Copy/Scan/Send/Fax*							
Standard duplex (reversing) 50 sheets							
C250i: Up to 25 ipm (one-side), Up to 9 ipm (double sided) C350i/C351iF: Up to 35 ipm (one-side), Up to 11 ipm (double sided)							
<table border="0"> <tr> <td>C250i</td> <td>C350i/C351iF</td> </tr> <tr> <td> 25ppm</td> <td> 35ppm</td> </tr> <tr> <td>(BW/colour)</td> <td>(BW/colour)</td> </tr> </table>		C250i	C350i/C351iF	 25ppm	 35ppm	(BW/colour)	(BW/colour)
C250i	C350i/C351iF						
 25ppm	 35ppm						
(BW/colour)	(BW/colour)						
34 sec (normal mode) 10 sec (quick start mode)							
C250i: 8.4 sec BW/10.5 sec colour C350i/C351iF: 5.9 sec BW/7.4 seconds colour							
17.8 cm (7 inch) TFT WVGA Colour LCD Touch Panel							
C250i/C350i: 650 sheets, C351iF: 2,300 sheets							
2,300 sheets							
Up to A4							
Cassette/s : 60 to 163 gsm. Mutli-purpose tray: 60 to 220 gsm Duplex: 60 to 163 gsm							
UFRII , PCL5/6 Standard Genuine Adobe PS3							
1.66 Ghz							
2.0 GB Memory and 160 GB Hard Disk Drive (usable space 80 GB)							
Ethernet (1000BaseT/100Base-TX/10Base-T), USB 2.0 Hi-Speed							
1 Watt or less							
1.5 kW							
Staple Finisher							

* Standard on C351iF

imageRUNNER ADVANCE C3300 series										
The imageRUNNER ADVANCE C3300 series provide high quality colour communication and streamlines document workflows. Its security and cost control features as well as its compact design make it ideal for busy workgroups.										
Print/Copy/Scan/Send*/Optional Fax										
Standard duplex (reversing) 100 sheets*										
55 ipm (one-side) 27.5 ipm (double-sided)										
<table border="0"> <tr> <td>C3320/i</td> <td>C3325i</td> <td>C3330i</td> </tr> <tr> <td> 20ppm</td> <td> 25ppm</td> <td> 30ppm</td> </tr> <tr> <td>(BW/colour)</td> <td>(BW/colour)</td> <td>(BW/colour)</td> </tr> </table>		C3320/i	C3325i	C3330i	 20ppm	 25ppm	 30ppm	(BW/colour)	(BW/colour)	(BW/colour)
C3320/i	C3325i	C3330i								
 20ppm	 25ppm	 30ppm								
(BW/colour)	(BW/colour)	(BW/colour)								
34 sec (normal mode) 10 sec (quick start mode)										
BW 5.9 sec Colour 8.2 sec										
17.8 cm (7") WVGA Colour Touch Screen with tilt functionality										
1,200 sheets										
2,300 sheets										
Up to A3 and SRA3										
Cassettes: 52 to 220 gsm , Multi-purpose tray: 52 to 256 gsm										
UFRII , PCL5e/6*, Genuine Adobe PS3*										
1.67 Ghz										
1GB + 1GB RAM and 250 GB HDD (215 GB usable space)										
Ethernet (1000BaseT/100Base-TX/10Base-T), USB2.0										
C3330i: 1.2 C3325i: 0.9 C3320/i: 0.8										
1.5 kW										
Internal Finisher Staple Finisher Eco Staple Staple-on-demand Booklet Finisher										

* Optional for C3320



imageRUNNER ADVANCE C5200 series

This powerful communication centre offering easy integration, security and cost control in an environmentally sound package, adds real value to busy offices.

Print/Copy*/Scan*/Send*/Optional Fax

Optional (one-pass and reversing available)
150 sheets/100 sheets

Up to 75 ipm (one-side)
Up to 120 ipm (double-sided)

C5235i 35/30ppm (BW/colour)	C5240i 40/35ppm (BW/colour)	C5250/i 50/45ppm (BW/colour)	C5255/i 55/51ppm (BW/colour)
---------------------------------------	---------------------------------------	--	--

31 sec (normal mode)
7 sec (quick start mode)

C5235i: 5.4 sec BW/8.1 sec colour
C5240i: 5.4 sec BW/8.1 sec colour
C5250/i: 3.9 sec BW/6.0 sec colour
C5255/i: 3.9 sec BW/6.0 sec colour

21.3 cm (8.4") TFT SVGA Colour Touch Screen with tilt functionality

1,200 sheets

5,000 sheets

Up to A3 and SRA3

Cassettes: 52 to 220 gsm, Multi-purpose tray: 52 to 256 gsm

UFR II
PCL5/6 (standard on i-models, optional for non-i models)
Adobe PS3 (standard on C5250i/C5255i, optional for the rest)
Optional EFI Fiery-based controllers

1.8 Ghz

2.5 GB RAM and 160 GB HDD
(160 GB usable space)

Ethernet (1000BaseT/100Base-TX/10Base-T), USB2.0

0.8 W

1.8 kW (51/45ppm), 1.5 kW (35/30ppm)

Internal Finisher
Staple Finisher
Booklet Finisher
2,4 and 2/4 Hole Punch tools

imageRUNNER ADVANCE C7200 series

These devices keep pace with the toughest office schedules, delivering performance and quality with professional finishing. Powerful security and unbeatable environmental credentials combine for a future-proof investment.

Print/Copy*/Scan*/Send*/Optional Fax

Optional (one-pass)
300 sheets

120 ipm (one-side)
200/140 ipm (double-sided, BW/colour)

C7260i 60/55ppm (BW/colour)	C7270i 70/65ppm (BW/colour)	C7280i 80/70ppm (BW/colour)
---------------------------------------	---------------------------------------	---------------------------------------

31 sec (normal mode)
7 sec (quick start mode)

C7260i: 4.9 sec BW/6.6 sec colour
C7270i: 4.9 sec BW/6.6 sec colour
C7280i: 4.4 sec BW/6.0 sec colour

21.3 cm (8.4") TFT SVGA Colour Touch Screen
Optional Upright 26.4 cm (10.4") TFT SVGA Colour Touchscreen

3,400 sheets

C7260i: 6,900 sheets
C7270i: 6,900 sheets
C7280i: 9,300 sheets

Up to A3 and SRA3

Cassettes: 52 to 220 gsm, Multi-purpose tray: 52 to 300 gsm

UFR II, PCL5/6
Optional Genuine Adobe PS3
Optional EFI Fiery-based controllers

1.8 Ghz

2.5 GB RAM and 160 GB HDD
(160 GB usable space)

Ethernet (1000BaseT/100Base-TX/10Base-T), USB2.0

0.9 W

C7260i/7270i: 2 kW/2.5 kW or less
C7280i: 2.5 kW

C7260i, C7270i:
Staple Finisher
Booklet Finisher
2,4 and 2/4 Hole Punch tools
Document Insertion/Folding unit

C7280i:
Staple Finisher
Booklet Finisher
Document Insertion unit
2,4 and 2/4 Hole Punch tools
Professional Puncher
Paper Folding unit
Trimmer

imageRUNNER ADVANCE office **black and white range**

A modular design ensures that each device can be efficiently tailored to meet your specific demands.



Core Functions
Reader/Document feeder
Scan Speed (A4, 300 dpi)
Copy/Print Speed A4
Warm-up time
First copy out time
User Interface
Paper capacity Std
Paper capacity Max
Paper size
Paper weights
Printer language
Processor
Memory/Hard Disk Drive
Interface
Power Consumption Sleep Mode
Power Consumption Max
Finishing options

imageRUNNER ADVANCE 500i/400i series
Suitable for busy workgroups and departments, these compact imageRUNNER ADVANCE devices offer efficient mono output and intelligent document handling to optimise your workflows, save you money and secure your confidential information.
Print/Copy/Scan/Send/Optional Fax
Standard duplex (reversing) 100 sheets
Up to 50 ipm (one-side) Up to 32 ipm (double sided)
500i: 50 ppm 400i: 40 ppm
34 sec (normal mode) 10 sec (quick start mode)
500i: 5.0 sec 400i: 5.0 sec
17.8 cm (7") TFT WVGA Colour LCD Touch Panel
650 sheets
2,300 sheets
Up to A4
Cassette/s : 64 to 105 g/m ² , Multi-purpose tray: 64 to 128 g/m ² Duplex: 91 to 105 g/m ²
UFRII , PCL5e/6 Standard Genuine Adobe PS3
1.66 Ghz
1.5 GB Memory/ 160 GB Hard Disk Drive (Usable space 80 GB)
Ethernet (1000BaseT/100Base-TX/10Base-T) USB 2.0 Hi-Speed
1 Watt or less
1.6 kW
Staple Finisher

imageRUNNER ADVANCE 4200 series
Efficient output and smart document workflows for busy workgroups and departments
Print/Copy* /Scan* /Send* /Optional Fax
Optional (reversing) 100 sheets
Up to 51 ipm (one-side) Up to 17 ipm (double-sided)
4225i: 25ppm 4235i: 35ppm 4245i: 45ppm 4251i: 51ppm
24 sec or less (normal mode) 10 sec (quick start mode)
4225i: 5.4 sec 4235i: 3.8 sec 4245i: 3.8 sec 4245i: 3.7 sec
21.3 cm (8.4 inch) TFT SVGA Colour Touchscreen
1,180 sheets
4,980 sheets
Up to A3
Cassettes: 60 to 128 g/m ² , Multi-purpose tray: 52 to 220 g/m ² , Duplex 52 to 128g/m ²
UFRII, PCL5e/6 Optional Genuine Adobe PS3
1.8 Ghz
1GB+256 MB (Plus optional 512 MB) Standard 160 GB HDD
Ethernet (1000BaseT/100 Base-TX/10Base-T), USB 2.0
1 Watt or less
1.5 kW
Internal Finisher Staple Finisher Booklet Finisher 2 and 2/4 Hole Punch tools (both internal and external)

* Requires image reader, printer-only version is available



imageRUNNER ADVANCE 6200 series

Offering fast and efficient mono output for demanding office environments, these smart multifunctionals will enhance your document workflows, protect confidential information and reduce environmental impact.

Print/Copy*/Scan*/Send*/Optional Fax

Optional duplex (One-pass)
300 sheets

120 ipm/85 ipm (one-side)
200 ipm/100 ipm (double-sided)

6255i: 55 ppm
6265i: 65 ppm
6275i: 75 ppm

30 sec (normal mode)
7 sec (quick start mode)

6255i: 3.3 sec
6265i: 3.3 sec
6275i: 3.1 sec

21.3 cm (8.4") TFT SVGA Colour Touch Screen
Optional Upright 26.4 cm (10.4") TFT SVGA Colour Touchscreen

4,200 sheets

7,700 sheets

Up to A3

Cassettes: 52 to 220 gsm, Multi-purpose tray: 52 to 256 gsm

UFR II, PCL5e/6
Optional Genuine Adobe PS3
Optional EFI Fiery-based controller

1.8 Ghz

1.5 GB RAM (expandable to 2.5 GB) and
160 GB HDD (160 GB usable space)

Ethernet (1000BaseT/100Base-TX/10Base-T),
USB 2.0

1 Watt or less

2.4 kW

Staple Finisher
Booklet Finisher
2,4 and 2/4 Hole Punch tools
Document Insertion/Folding unit





Awards



Canon, Inc.
Universal Login Manager
Outstanding Achievement
in Innovation



Canon, Inc.
2013 Document Imaging Solutions
Line of the Year



Canon, Inc.
iW Desktop Quick Printing Tool
Outstanding Achievement
in Innovation



Canon, Inc.
A3 MFP Line of the Year Award
for Energy Efficiency



Advance
your business
potential with
imageRUNNER
ADVANCE

Software and solutions



Certifications and compatibility



All images used in the brochure are for illustrative purposes only. All specifications are subject to change without any notice. All company and/or product names are trademarks and/or registered trademarks or their respective manufacturers in their markets and/or countries.

Canon Inc.
Canon.com

Canon Europe
canon-europe.com

UK English edition
© Canon Europa N.V., 2015

Canon (UK) Ltd
Woodhatch
Reigate
Surrey RH2 8BF
Telephone No: 01737 220000
Facsimile No: 01737 220022
canon.co.uk

Canon Ireland
3006 Lake Drive
Citywest, Saggart
Co.Dublin, Ireland
Telephone No: 01 2052400
Facsimile No: 01 2052525
canon.ie

/CanonUKLtd

/CanonUKLtd

/CanonEurope